

BRICON

SPEEDY X-TREME



User Guide

United Kingdom

Version UK v2.03 or higher

BRICON nv

Europark Oost 15c, 9100 Sint-Niklaas, Belgium.

Tel: +32 3 777 39 74 email: bricon@bricon.be

International website: www.bricon.be UK website: www.briconuk.com

Extra Special Features

Bricon Print Manager •• Bricon Monitor •• BriconWeb

The Speedy X-treme clock with its integrated USB port gives you computer connectivity and free access to special software programs that can transform and revitalise your enjoyment of the sport and open up new horizons to take pigeon racing into the 21st century.



PRINT MANAGER enables the data held on the Speedy X-treme to be transferred and saved onto a home computer or lap top, so that at any time it can be viewed or printed. This includes the details of your birds and your clockings from races and training flights which will give you the means to assess and analyse the performance of your team of birds.

BRICON MONITOR lets you watch live as the clocking times of your birds appear instantly on the screen of your computer or lap top connected to the Speedy X-treme with the USB cable. The full ring number of each bird and its clock time will show on screen along with its velocity, with a choice of bells and whistles available to alert you to when a bird is recorded.

EMAIL. The monitor also gives the option to send automated emails to any number of email addresses giving alerts of your birds arrival times to your computer, lap top, ipad or smart phone.

BRICON WEB gives you the option to also have the full details of your clockings sent to the Bricon server, so that the clocking time of each of your birds will be displayed live and in real time on the web alongside the clockings of fellow race competitors that choose to do likewise. Clockings can show live as they happen on a map, bringing new found excitement to a race.

THE USER GUIDE for these features can be downloaded from the **Bricon UK website.**

www.BriconUK.com

SPEEDY X-TREME SECURITY

- *Security is paramount to Bricon and the Speedy X-treme employs a safe housing system sealed at production.*
- *A system can only be compromised if its electronic driving system is accessed, but the Speedy X-treme will not allow this without damage to the housing.*
- *TNO reports prove the efficiency of this technique.*
- *The Speedy X-treme also has a visible security stud found on the top right hand front corner of the clock. This security stud should remain intact at all times.*
- *Furthermore the Speedy X-treme has a holographic security sticker attached to the side of its housing which should remain in place at all times.*
- *The Speedy X-treme therefore does not require any accessible screws which can be open to abuse or argument.*



Index:

	Page
1. The Bricon electronic timing system	4
1.1. Foreword	4
1.2. The Speedy X-treme system	4
1.3. Assembly schematic of the Bricon timing system	4
1.4. The Power Supply - Mains Electricity	5
1.5. Power from a Battery	5
2. Speedy X-treme functionality	5
2.1. Get started by Powering the system	5
2.2. The Keypad Buttons	5
2.3. The Menu	6
3. The Antenna Pad.	6
3.1. Pads available in different sizes - your choice	6
3.2. Connecting additional Antenna Pads	6
3.3. Programming an identity into additional Antenna Pads	7
3.4. Antenna Testing	7
3.5. Antenna Pad placement	8
4. Get up and running with the system	11
4.1. Input Fancier	11
4.2. Linking Birds	12
4.3. Pigeon List	12
4.4. Clocking Birds from Training	13
5. Racing with the Speedy X-treme	14
5.1. Competing in a club that uses a Bricon Club-Master	14
5.2. Competing in a club that uses an alternative brand of master	14
5.3. Basketing on an alternative brand of club master	14
5.4. Read out on an alternative brand of club master	16
5.5. To Delete a race from the Speedy X-treme	16
6. Additional Functions and Features	17
6.1. Setting the Date and Time	17
6.2. Basketed Races	17
6.3. Racepoints	17
6.4. Start up Information	18
6.5. Antenna Alarm	18
6.6. Continuous Clocking with the Bricon Plus	18
7. USB Connector >>> Bricon Print Manager • Monitor • BriconWeb	18
7.1. Software Updates	18
8. Unives 1.7 Compatibility	18
9. Maintenance and Service	18
10. Frequently Asked Questions	19
11. Declaration of Conformity	20
12. Technical Specifications	20

1. The Bricon electronic timing system.

1.1. Foreword.

Thank you for your trust and confidence in BRICON.

This user guide will give an explanation of the primary functions of your Speedy X-treme clock.

The USB user guide that covers the special functions is available on the Bricon UK website.

1.2. The Speedy X-treme system.

A complete Speedy X-treme system pack contains:

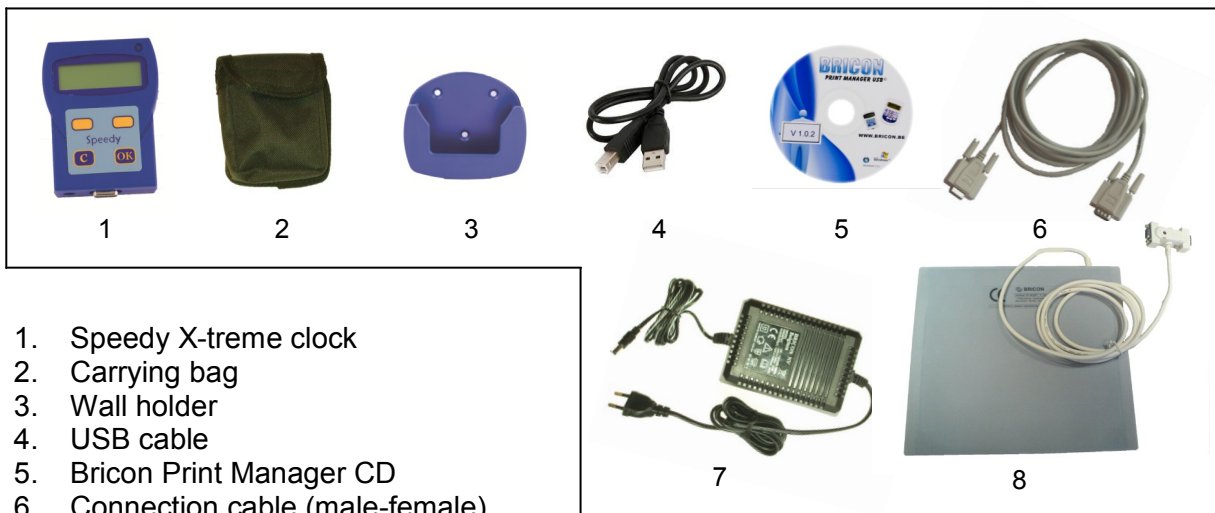

1. Speedy X-treme clock
2. Carrying bag
3. Wall holder
4. USB cable
5. Bricon Print Manager CD
6. Connection cable (male-female)
7. Power supply (12 volt transformer)
8. Antenna pad (with 1.8 metre integral cable).

1.3. Assembly schematic of the Bricon timing system.

- The assembly shown here is of a two antenna pad system.

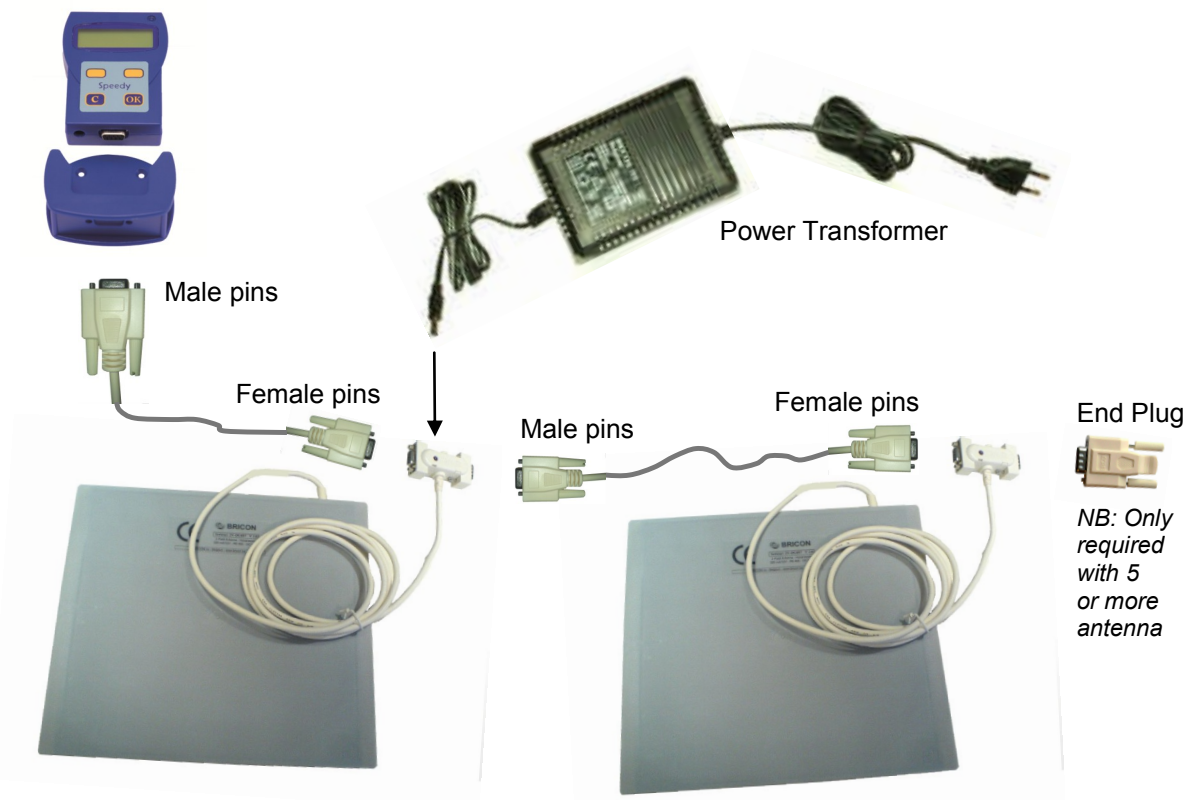

1.4. The Power Supply - Mains Electricity.

- The Bricon power supply is a 12 volt Transformer with a max rating of 1500mA (milliamps).
- This powerful and sturdy transformer is ample for any Bricon single antenna pad system.
- An additional power supply may be required when multiple antenna pads are connected.
- You can calculate your own system power requirements as each antenna is labelled with its power needs (from 290mA to 700mA) depending on size of the pad. The Speedy X-treme uses a further 70mA, so a calculation can be made to see if more than 1500mA is required.
- The power jack should be plugged into the jack socket on the Antenna T-connector.
- In a multiple antenna pad system, the power should be connected into the antennas so as to distribute the power around the system as evenly as possible.

1.5. Power from a Battery.

Lofts that are without mains electricity have the option to receive power for the Bricon system from a 12 volt battery using a Battery Connection cable. The crocodile clips on the cable will connect to any standard 12 volt battery, such as a car battery or a leisure battery.

2. Speedy X-treme functionality.

2.1. Get started by Powering the system.

Connect the Speedy X-treme clock within the system as illustrated in the plan in section 1.3. Turn on the power supply and the Speedy X-treme will power up and proceed through its initialisation process.

Press the <C> button and the menu of the Speedy X-treme will show on the display.



2.2. The Keypad Buttons.



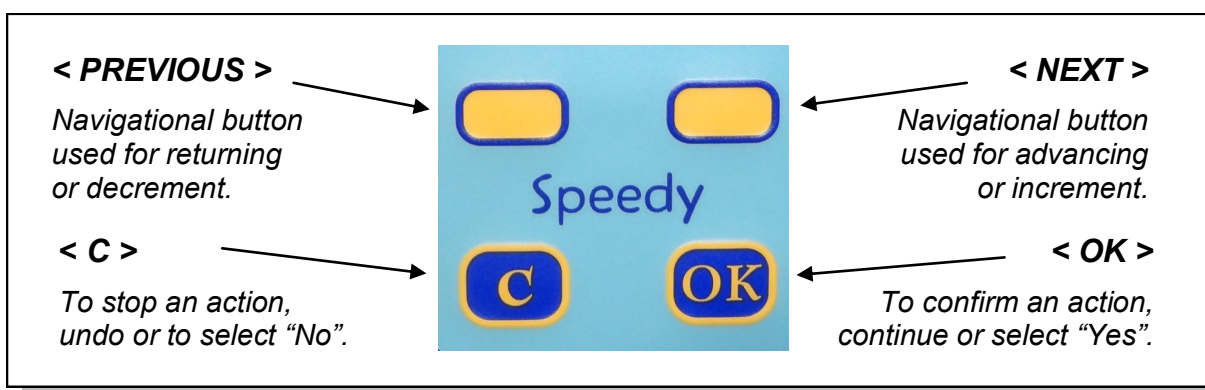











The Speedy X-treme is very easy to use having only four buttons on the keypad which fully control the functionality of the clock. The four keys are as follows -

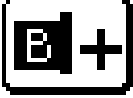
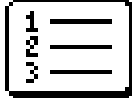

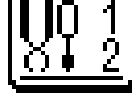
2.3. The Menu.

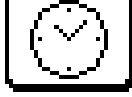
The complete functionality of Speedy X-treme is accessed through a menu using 10 main functions and 7 sub-menu functions, each graphically presented by an icon, set up in order of frequency of use. The icon that is required should be positioned in the centre of the Speedy X-treme display using the orange navigational buttons <PREVIOUS> and <NEXT> and then accessed by pressing the <OK>.

Listed below is each icon and its function.

 <i>Clocking</i>	 <i>Delete</i>	 <i>Basketed races</i>
 <i>Basketting</i>	 <i>Read out</i>	 <i>Testing antennas</i>
 <i>Linking</i>	 <i>Pigeon list</i>	 <i>Racepoints</i>
 <i>Set up >>> Press for the Sub-Menu options</i>		 <i>Program Ant.</i>
 <i>Fancier</i>	 <i>Set time</i>	 <i>Language</i>
 <i>LCD Colour</i>	 <i>Printing</i>	 <i>Print Training</i>

Please note: By holding down the <C> button you can see the text name of the icon.

3. The Antenna Pad.

3.1. Pads available in different sizes - your choice

Bricon produces four sizes of antenna pads, with special technology that has electro-magnetic fields that uniquely overlap, and thus are the only pads designed to be used without tunnels.

- One Field = 163 mm wide.
 - Two Field = 282 mm wide
 - Four Field = 482 mm wide.
 - Six Field = 683 mm wide.
- All pads are 253 mm deep and 22 mm thick.
All pads have an 1.8m integral cable to its T-Connector.

3.2. Connecting additional Antenna Pads.

Additional antenna pads can be connected within the system with a Bricon connection cable which has a 9-pin male connector on one end and a 9-pin female connector on the other end. An end plug should only be fitted to the system when five or more antenna pads are connected. The Speedy X-treme will operate with up to 6 antenna pads of any size, and where 7 or more antennas are required then a Bricon Antenna Buffer must be connected within the system.

3.3. Programming an identity number into additional antenna pads.



When two or more antenna pads are connected in the same system, it is very important that each antenna is given its own internal identity (numbered between one and six). If two pads have the same identity number then at some stage there will be a data collision when the clocking information is forwarded to the clock and the system may cease to function.

Each antenna pad retains its own identity number within its own memory, and when purchased each antenna is pre-set as a number 1. When two or more antenna pads are connected then each pad in the system must be programmed to have its own identity number between 1 and 6.

The programming of each antenna pad should be carried out using the following procedure.

- (i) Ensure that the Speedy X-treme and each antenna are disconnected from one another.
- (ii) Connect the power supply directly into the bottom of the Speedy X-treme clock.
- (iii) After starting up the display will show 'Search antennas - Antennas NOT found!'
- (iv) Press <OK> and then navigate along the menu to the Setup icon and press <OK>.
- (v) Press the <PREVIOUS> button once to reach the 'Program Ant' icon and press <OK>.
- (vi) Connect one antenna pad to the base of the Speedy X-treme clock and press <OK>.
- (vii) Press the <NEXT> button until the required number appears (between 1 and 6 only).
- (viii) Programming is successful if the Speedy X-treme shows 'Program Ant.: nr Ok!'
- (ix) If 'No Antenna available' appears, repeat the process ensuring that OK is pressed promptly.
- (x) Disconnect the pad from the Speedy X-treme and repeat the process for additional pads.

3.4. Antenna Testing.



This function can be used to test the detection quality of the antennas fields and to confirm that the antenna pads have been numbered correctly.

- (a) Connect the antenna pads together in the full system.
- (b) Connect the Speedy X-treme clock and go to the 'Antenna Testing' icon and press <OK>.
- (c) A search will then be carried out by the Speedy X-treme for connected antenna pads.
- (d) If for example, three pads are connected the Speedy X-treme display should indicate...

First Line → The number of different antenna pad identities found in the search.

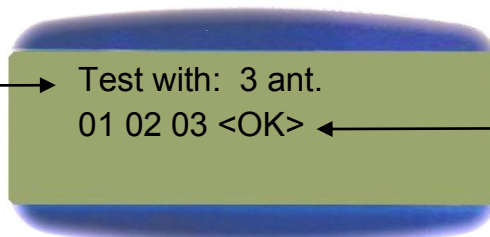

← Second Line The antenna pad identity numbers found in the search.

- (e) Press <OK> and hold a Bricon chip over an antenna pad and the clock will start beeping.
- (f) The display will show the chip number (C5..), the identity nr of that antenna (#) and the time.

Antenna Testing allows you to confirm that the antenna installation has been carried out correctly and the registration quality of the electronic chip is good.

The Speedy X-treme should beep repeatedly if the electronic chip is held above the antenna at a height of 5 to 7 cm (2 to 3 inches).

VERY IMPORTANT: *If the numbers of antennas shown does not match the actual number of antenna pads connected, then two antenna pads may have been given the same internal identity number indicating that the antenna programming has not been carried out correctly. Carry out testing on each antenna pad and check that the identity number for each pad is as intended.*

3.5. Antenna Pad placement.

Very Important : Metal should not be situated near the antenna pad
(either underneath or above the pad).

Metallic items, such as metal hinges, bars or wire mesh can cause undue interference to the timing system, causing the system to malfunction or cease operating.

Interference can also be caused by electrical devices and other electro-magnetic fields.

As the signal will pass through most non-metallic materials, it is recommended to install the pad either above or beneath the loft entrance board (eg: plywood of no more than 15mm thickness). It is important that air-flow is allowed to the pads to enable the cooling process to take place.

The entrance hole to the loft must be at least 2 cm narrower than the width of the antenna pad.

Bricon antenna will record over the entire width of the pad and therefore tunnels are not needed. It is advisable however to slow down the bird before it steps onto the antenna. The base of the pad is the side bearing the label and pad number, and this should be installed face down.

It is advised to install the pads at least 1 metre away from each other to avoid interference.

NB: New generation pads (4 & 6 field - 2009 model onwards) can be placed next to one another.

Antenna positioned under the landing board and before the bob wires

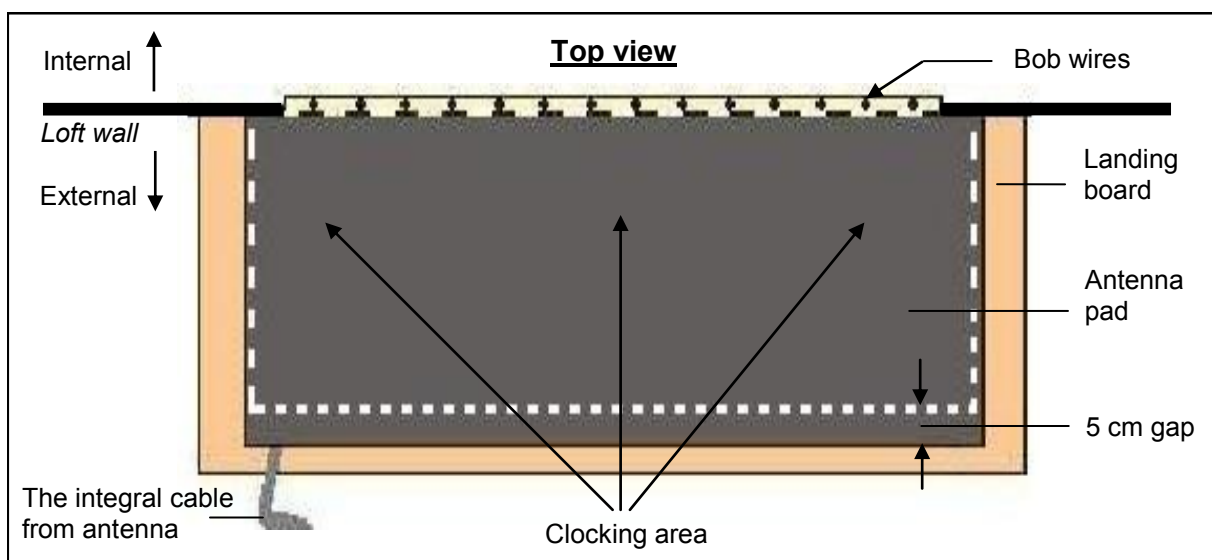
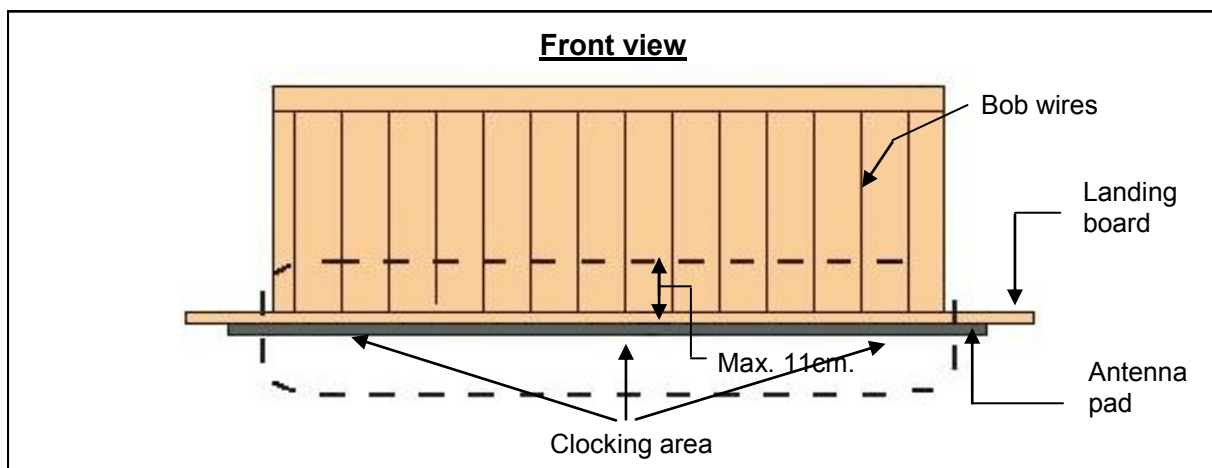

In this set-up, install the antenna pad with the integral cable leading to the outside of the loft.

Antenna pad positioned inside of the loft entrance and behind the bob wire

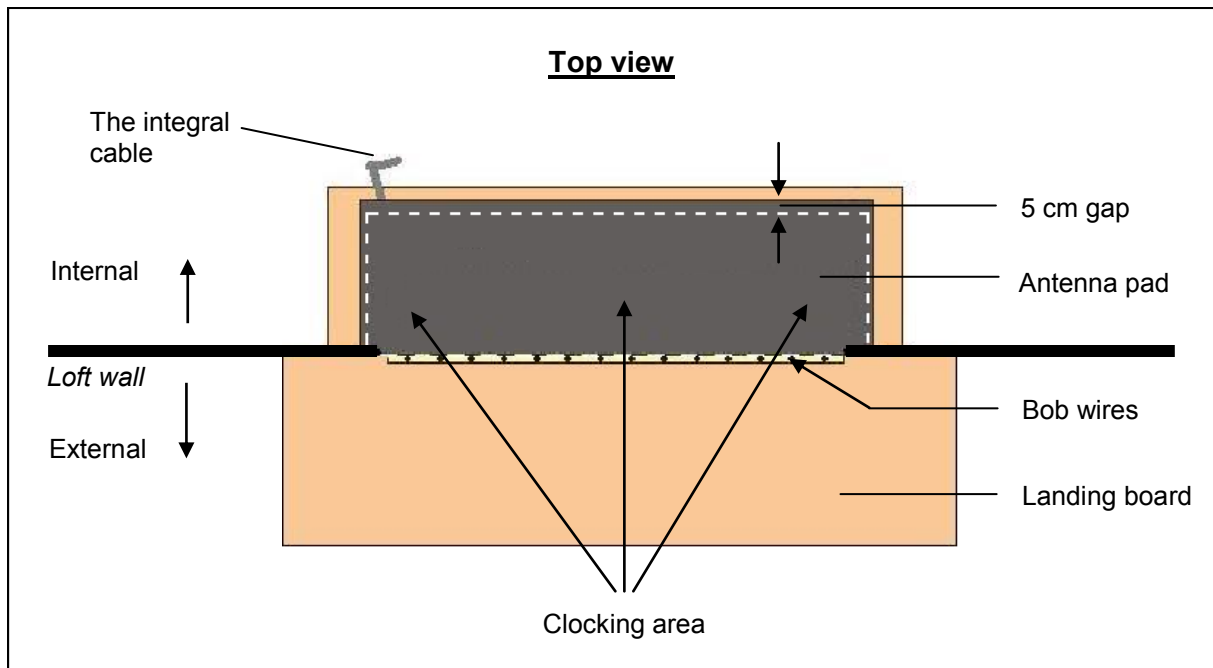

In this set-up, install the antenna pad with the integral cable leading to the inside of the loft.

With tunnels

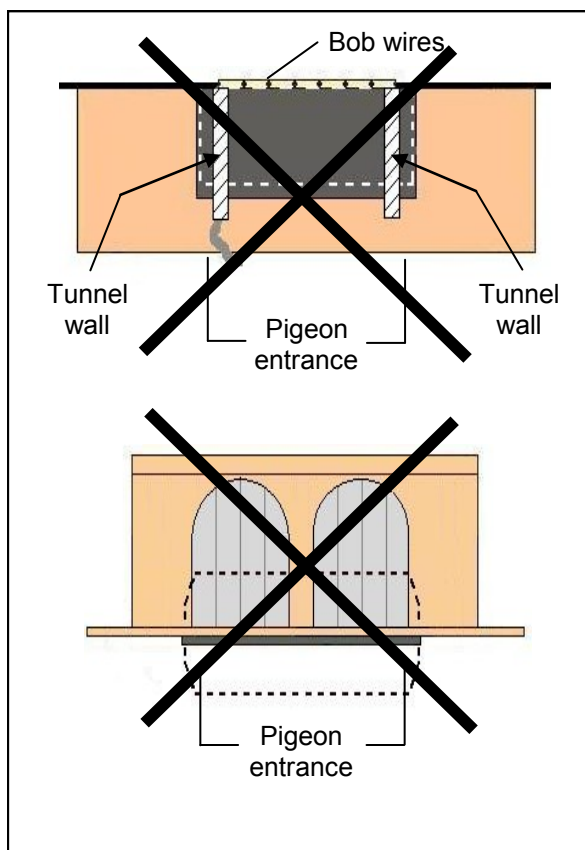

Without tunnels

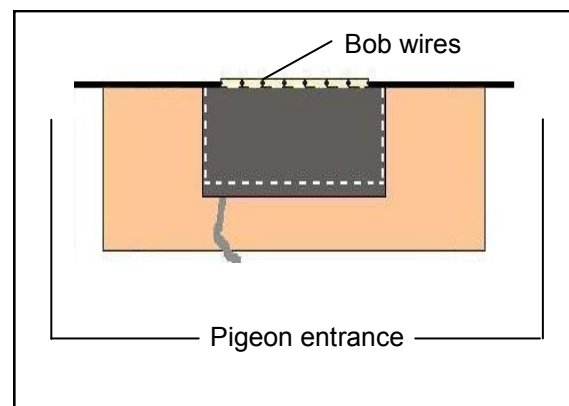

With Bricon antenna pads it is not necessary to place a tunnel over the pad because of the unique way in which the electro-magnetic fields actually overlap each other.

Having to place a tunnel over the pad and entrance will in most circumstances prove to be a major disadvantage, with pigeons crowding into the entrance area resulting in jams and delays in the timing of the birds.

Clocking multiple pigeons on one antenna

If it is necessary to clock many pigeons on one antenna pad at the same time, it is advisable to install the antenna pad as follows.

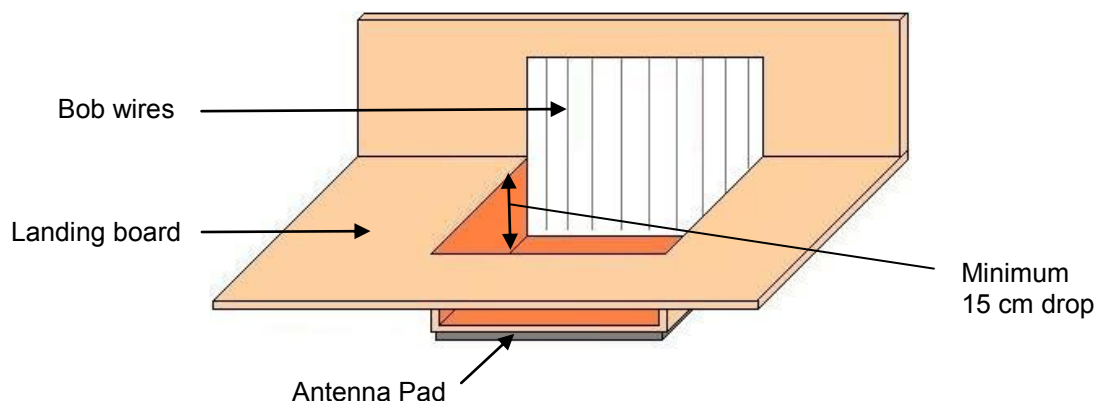

On the landing board, you should build an area which is lower, under which the antenna pad is then installed. The pigeons will then step onto the antenna pad one by one and not all at the same time and as a result the registration of the birds is optimised.

Another method that gives similar results is to build a raised area. This raised area is also needed if you have a landing board made from zinc, as metal causes interference to the antenna. The raised area should be a maximum 10cm higher than the base, and the board a maximum thickness of 15mm.

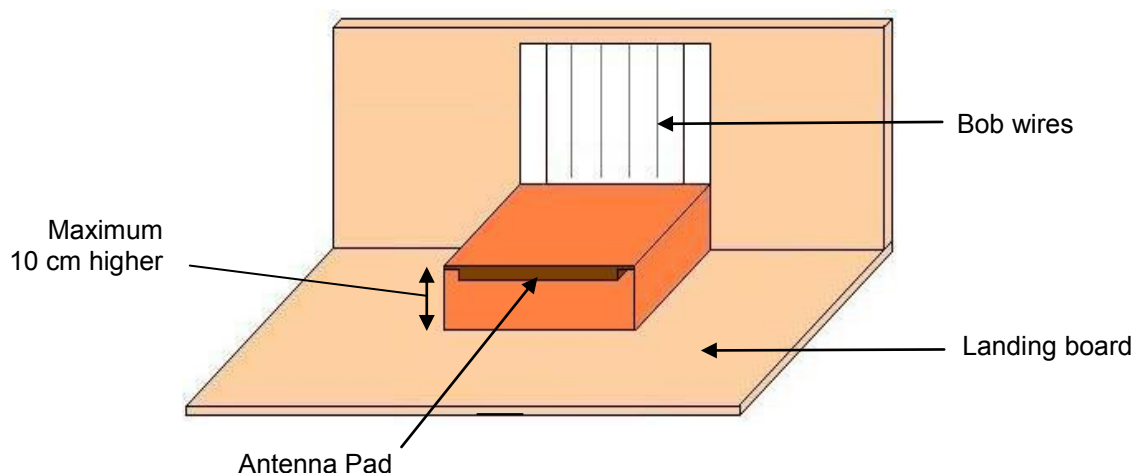

You may find it more convenient to purchase a specially designed entrance. If you choose this solution we recommend the Futura (designed by Bricon and produced by the companies Demster and Haspeslagh in Belgium).

ATTENTION: It is recommended that great care is taken to ensure that the positioning of the antenna complies fully with the rules and regulations of the relevant governing body.

4. Getting up and running with the system.

After programming additional antennas pads (see section 3.3) and installing the antenna system within the loft (see section 1.3), the power supply can then be connected to the system. The Speedy X-treme can be connected either prior to or after the connection of the power supply. The red light on the Antenna T-Connection box will illuminate, indicating that power is received.



- *Firmly push the Speedy X-treme into its wall holder.*
 - *The clock will start up and carry out a search for antennas.*
 - *As no pigeons have yet been linked, the Speedy X-treme will progress to antenna testing (see section 3.4).*
 - *The connection to the antenna can be tested if required, by pressing <OK> and placing an electronic chip on the pad.*
 - *Press the <C> button to go to the main menu of the clock.*
-
- ***Important:*** *If after the antenna search, the Speedy X-treme displays the message 'Search Antennas - Antennas NOT found!' then it indicates that the antenna search failed to find a connection with the antennas.*
 - *In that instance, check that all connections are firmly pushed fully together.*
 - *Ensure that the Speedy X-treme is fully pushed into the wall holder to ensure a good connection. Avoid having any debris sitting within the wall holder or over-tightening the connection cable into the base of the holder.*

4.1. Input Fancier.

Your racing name and loft number can be entered into the clock by either of two ways.

- COMPUTER ENTRY using the software program 'Bricon Club-Editor'.
NB: Club-Master is not required and this also enables entry of the address.
- DIRECT ENTRY into the Speedy X-treme clock as explained in the box below.



- *Move in the sub-menu to 'Fancier' and press <OK> to confirm.*
- *The display will request 'Give name'*
- *With the buttons <PREVIOUS> and <NEXT> you can scroll through the fancier list. Press <OK> to confirm if you want to modify or change the name of the fancier.*
- *An empty field of 20 characters appears. Using <PREVIOUS> and <NEXT> a letter can be found. Continue pressing until you find the correct letter and confirm with <OK>. The cursor then moves to the right and you can repeat the action for the next letter. (NB: The space character can be found after the letter Z).*
- *On the second line you can add your official loft number, which should be entered in the format of two letters and five numbers.*
- *On completion, the Speedy X-treme will request confirmation by pressing <OK> or cancelling the action with <C>.*

NB: To confirm that the name is entered, press <C> and the name will show on the display.

4.2. Linking Birds.

The next task is to add pigeons to the clock. An electronic chip ring must be assigned to each pigeon that you wish to time using the system, and with the Speedy X-treme you can link up to 300 birds.

There are two possible ways to enter birds into the Speedy X-treme.

- COMPUTER LINKING using the software program 'Bricon Club-Editor'.
Please note: members of the NEHU should use this option.
- DIRECT LINKING to the clock with a loft antenna pad as the chip reader.
The procedure for this is explained in the box below.



- Navigate in the menu to the 'Linking' icon and press <OK>.
- The clock display will then request that you 'Present chip'.
- Place the electronic-ring on the antenna. Upon reading the chip, the clock will beep and a blank life ring-number will show.
- A ^ cursor will be seen under the first character, indicating the letter or number that is next to be amended.
- Select the required letter or number by pressing the orange navigation buttons <PREVIOUS> or <NEXT> until the required letter or number appears under the ^ cursor.
- Confirm with <OK> and the cursor moves to the next character.
- Continue this process for the complete ring number, before you can then enter the colour of the pigeon using four characters.
- The final option is to select the sex of the pigeon.
- On completion, the Speedy X-treme will request that the linkage is confirmed by pressing <OK> or cancelled with <C>.
- By repeating the procedure the next pigeon can be entered.
- NB: Linking is blocked when races are active on the clock.

Four characters are available for the country or union, followed by two for the year of the bird. Nine characters are available for the letter and numbers of the pigeon and it is recommended that the ring number is entered into the final character spaces, with the spaces used at the start.

The advised format for GB rings is ... GB(space)(space)-16-(space)(space)A(space)12345

NB: The space character can be found directly before the letter A and directly after the number 9. When on the space, the left orange button takes you to numbers and the right button to letters.

Chip already linked - indicates that the electronic chip ring is already linked to another pigeon.

Double ring - indicates that an attempt has been made to link a chip to a pigeon ring that is already in the system. The link is denied and old link must be deleted before proceeding.

4.3. Pigeon List.



- This icon allows you to view the birds linked on the clock.
- Scroll through the linked birds with <PREVIOUS> and <NEXT>.
- Any bird recorded from a race, will also have displayed the date and time of its clocking plus its position, the racepoint and club id.
- If the clock is clear of races, then it is possible to delete pigeons.
- Select a bird with <PREV> and <NEXT> then press <OK> and the clock will request confirmation for the pigeon to be deleted.
- Press <OK> to confirm or <C> to cancel the deleting process.

4.4. Clocking Birds from Training.



- When powered the Speedy X-treme carries out a search to determine the mode in which it should start-up.
- If no connected loft antennas are found, the display will show 'Search antenna - Antennas NOT found!'
- If connected antenna pads are found the Speedy X-treme will show either 'Clocking with: x Ant - Waiting for pigeon' or the last recorded pigeon if previous clockings are on the clock.
- NB: For security, if a race is active on the Speedy X-treme then it is impossible to leave clocking-mode.

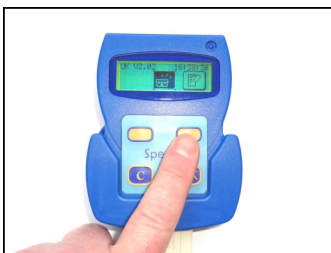

- When no active races are on the Speedy X-treme, pressing <C> deactivates 'clocking-mode' and the main menu appears.
- The orange buttons <PREVIOUS> and <NEXT> can then be used to scroll through the menu. Position the required icon in the centre of the display and confirm with <OK>.
- To record birds from a training flight, it is necessary to first delete the clockings of the previous training flight.

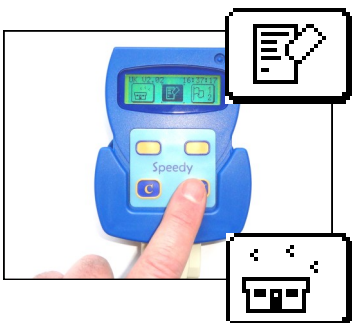

- **To delete training flights:** Select the 'Delete' icon and confirm with <OK> and all training clockings will be erased.
NB: The clockings of active races will not be deleted.
- **Clocking:** Select the 'Clocking' icon and confirm with <OK> and the Speedy X-treme will return to clocking mode ready to record training flights.



- After pigeons have been recorded home, the orange navigation buttons <PREVIOUS> and <NEXT> allow you to scroll through the full list of clockings, moving backwards and forwards from the first to last pigeon.
- When a pigeon arrives the display will automatically show the latest clocking.

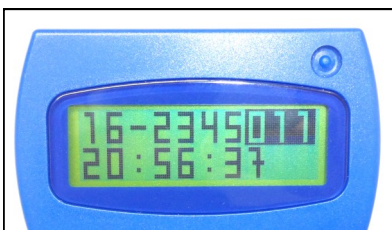

By pressing the <OK> button the screen display will alternate between a large sized print display and a smaller sized but more detailed print display.

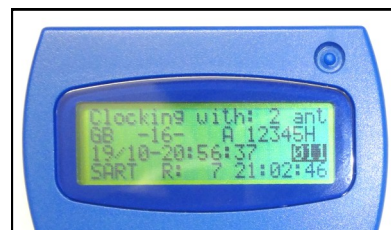

5. Racing with the Speedy X-treme.

5.1. Competing in a club that uses a Bricon Club-Master.



Refer to the **BRICON CLUB-MASTER** user guide for the instructions for basketing and read-out.

5.2. Competing in a club that uses an alternative brand of club master.

(eg. Benzing, Tauris, Unikon etc).

The Speedy X-treme clock is fully compliant with the Unives 1.7 Protocol so can be used to race basket on any brand of club master system that also complies with the agreed Unives protocol.

The Bricon Unives Cable (supplied with a system package) will be required to physically connect the Speedy X-treme to an alternative brand of master. The Unives cable has a nine-pin male connector on one end to plug into the base of the Speedy X-treme, whilst on the other end is a round four-pin male connector to connect to the alternative brand of club master.

5.3. Basketing on an alternative brand of club master.



- *The Speedy X-treme can be used with any brand of club master unit that complies with the Unives 1.7 protocol.*
- *A club-master unit is a club basketing antenna and a time signal synchronised master clock.*
- *NB: The club master must have received its time synchronisation from a genuine automated time signal if the Speedy X-treme is to be able to time synchronise and race mark.*



- **Basketing:** *A Bricon unives cable is needed to connect the Speedy X-treme to the unives connector of the master.*
- *After start-up, the clock will recognise that it is connected to a club master and will show the 'Basketing' icon.*
- *Press <OK> on the Speedy X-treme to confirm basketing.*



- The display of the Speedy X-treme will show 'Choose race' followed by a racepoint name or number (eg Race 0001).
- Select the required racepoint (or if not loaded a Race number) by pressing the <PREVIOUS> and <NEXT> and confirm with <OK>.
- The option to select another race identifier will show with 'Race ?' used when a race is already basketed from the same racepoint. If required press <NEXT> and thereafter press <OK> to proceed.



- The Speedy X-treme will then synchronised itself against the time signal on the club basketing system.
- 'Basketed birds 0' will show on the Speedy X-treme display and race marking can commence for the first pigeon.



- Present the pigeon's electronic chip-ring to the club antenna.
- The clock will beep and the ring number will show on screen.
- Check that the ring number displayed corresponds to that on the pigeon before pressing <OK> to confirm its entry into the race.
- The pigeon can then be placed into the basket for the race.
- Repeat this process for each pigeon.



- If a pigeon is presented bearing an electronic chip that does not match its existing link, the clock will show 'Chip not linked'.
- If an 'emergency link' is required for that pigeon, press <OK>.
- Use <PREVIOUS> and <NEXT> to scroll through the birds linked on the clock until the ring number of the pigeon appears.
- Press <OK> to confirm the emergency link of the pigeon to its new electronic chip ring, and then <OK> again to basket the bird.



- To close basketing, press <C> on the Speedy X-treme.
- If there are no more birds to basket for the race for that fancier, press <OK> to finalise basketing.
- Select the number of copies required of the basketing list using the <PREVIOUS> and <NEXT> and then press <OK> to print.
- The Speedy X-treme can be disconnected from the club-unit.



- At the loft, push the Speedy X-treme firmly into its wall holder.
- Always then check that the clock is ready to record birds by confirming that 'Clocking with: x ant - Waiting for pigeon' shows on its display (where x = number of connected pads).
- If the clock shows 'Search antenna - Antennas NOT found!' then the system is not correctly connected and will not record birds.

5.4. Read out on an alternative brand of club master.



- When the race is completed, disconnect the Speedy X-treme clock from its wall holder.
- Return to the club headquarters and connect the Speedy X-treme to the club-system using the Bricon Unives cable.
- Scroll right with <NEXT> to select the 'Read out' icon from the Speedy X-treme main menu and press <OK>.



- With the clock displaying 'Choose race' press <OK>.
- A race will be displayed with its date and time of basketing.
- Navigate to another race if required with <PREV> and <NEXT> and when the desired race shows on screen press <OK>.
- Choose whether to 'close' the race with <OK> or if not the <C>.
- Select the number of copies required of the Clocking List using <PREVIOUS> and <NEXT> and then press <OK>.
- The time synchronisation with the master is then carried out automatically and the Clocking List for the race will be printed.



- Race closure: If the race was closed by pressing <OK> then it will have become a status code 15, meaning that the race is now ready and waiting for deletion. (see sect 6.2. for status codes)
- If the <C> was pressed, the race was not closed and remains fully active as a status code 07 race and is not ready for deletion.

5.5. To Delete a Race from the Speedy X-treme.

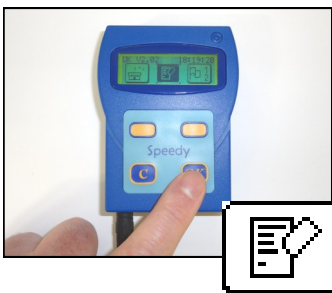

- After any race has been closed, the race must then also be deleted from the Speedy X-treme using the following routine.
- Connect the Bricon power supply jack directly into the base of the Speedy X-treme clock with no antenna pads connected.
- Using the <NEXT> button proceed to the 'Delete' icon.
- Press <OK> to delete all races that have been closed (status 15).
- Races anything other than status 15 will remain on the clock.
- NB : If a race is not closed and deleted then the birds within that race will not be allowed to be basketed for any future race.

6. Additional Functions and Features.

6.1. Setting the Date and Time.



- The 'Set time' icon enables the date and time to be set.
- Use the <NEXT> and <PREVIOUS> buttons to change a number and the <OK> to confirm the selected number.
- NB: When basketing for a race, the Speedy X-treme will time synchronise automatically to the club master mother clock, and this function is de-activated when any race is on the clock.

6.2. Basketed Races.

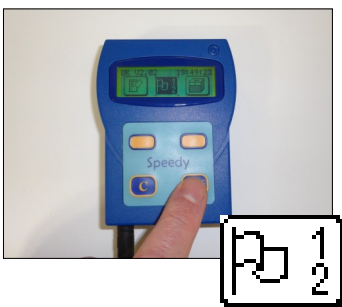

- Navigate to the 'Basketed races' icon and press <OK> to view the races that remain active on the Speedy X-treme.
- Press <NEXT> to scroll through each of the races on the clock.
- For each active race, the displayed info is the date and time when basketed, the race status, racepoint and club ID. for example

Race: 01	15:25:11
22.04.16	18:36:25 01
	EXET5678

Race
Date, Time, Status
Racepoint, Club ID

For races basketed on a Bricon Club-Master the standard status codes are

- ⇒ Status 01. Race opened.
- ⇒ Status 05. Birds timed.
- ⇒ Status 07. Read out printed, but race not closed.
- ⇒ Status 15. Read out printed and race closed ready for deletion.

Attention: An active race can only be deleted from the Speedy X-treme if it is status 15.

The only way to progress a race to become status 15 from any other status is to return back to the master and repeat the read out print and when requested close the race by pressing <OK>.

6.3. Racepoints.

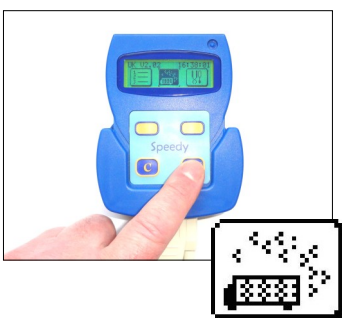

The Speedy X-treme can hold up to 128 racepoint names which can be selected from a list on the Bricon Club-Editor computer software program and transferred directly onto the Speedy X-treme clock via a USB connection, without the need for a Bricon Club-Master.

- To view the racepoints held on the clock, navigate to the racepoints icon press <OK> and scroll through with <NEXT>.
- Racepoints should be sent to the Speedy X-treme for races that are to basketed on a non-Bricon brand of club master.
- NB: When basketing with a Bricon Club-Master, the racepoint is selected from the list of racepoints held on the Master.

6.4. Start up Information.

On powering up, the Speedy X-treme will briefly show on its display the following numbers.

P (Pigeons on clock) B (Basketed race birds)
C (Clocked race birds) R (Races active on clock).

The recommended date for a Bricon service will also be displayed.

6.5. The Antenna Alarm.

As part of its start up process the Speedy X-treme clock carries out a search for connected antenna pads and displays the number of different antenna pad identities that it has found in the search.

The Speedy X-treme will continue to carry out regular antenna searches, and if at any time fewer pad identities are found than on the initial search (say due to a connection problem), then the antenna alarm will activate, giving a long continuous sound. Action can then be taken to find and rectify the issue. Please note that if the power to the clock is lost, then the antenna alarm will not be able to function.

6.6. Continuous Clocking with the Bricon Plus.

The Speedy X-treme is fully compatible for use with the 'Bricon Plus' the optional reserve clock that can take over and continue to record birds when the Speedy X-treme is removed to go to the club house. The 'Bricon Plus' reserve clock is available from your Bricon supplier.

7. USB Connector >>> Bricon Print Manager - Bricon Monitor - BriconWeb.

The Speedy X-treme clock has an integrated USB port giving computer connectivity and FREE access to a range of special programs and options to enhance your enjoyment.

These added features are briefly described on page 2 of this guide, but a fully detailed special online USB user guide for these elements highlighting the very latest attributes can be downloaded from the Bricon website.



USB port

7.1. Software Updates.

The Speedy X-treme can receive free software updates direct from a connection to the Internet. Connect the clock (using the USB cable supplied) to a computer with the Bricon Print Manager and the latest clock software will download without the need for a master. See the online user guide for details.

8. Unives 1.7 Compatibility.

The Speedy X-treme clock is fully compliant with the Unives 1.7 protocol, and can therefore be used with any brand of master system that also supports the agreed and established Unives 1.7 protocol.

Bricon supplies a Bricon Unives Connection Cable, that has a 9 pin male connector to plug into the clock and a 4 pin male round connector to connect to the unives socket of the variant brand of master.

9. Maintenance and Service.

- The Speedy X-treme should only be used for the electronic timing of racing pigeons.
- Ensure that the Speedy X-treme is kept away from liquids, sunlight and extreme temperatures.
- Clean the Speedy X-treme by removing dirt with a lightly dampened cloth and do not use solvents.
- The recommended service date is displayed on start up which is a minimum 7 years from purchase.
- For customer confidence and reassurance, the clock has the self diagnostic Bricon Battery Control System (BBCS) that will give a warning message on screen should the clock develop a low battery.
- All repairs and service to the system should be referred to and ultimately carried out by Bricon.

10. Frequently Asked Questions.

SYSTEM SET-UP

- Q. How can I check that my name has been entered correctly into the Speedy X-treme ?
A. When on the menu, if you hold down the C button, then both your name and the icon description will appear.
- Q. What is wrong if my Speedy X-treme lights up when connected, but shows 'Antennas not found! ?
A. The clock may not have been fully pushed in all the way, as the first part of the push only powers the clock. Check that there isn't something in the base of the wall holder stopping the clock from going fully in.
- Q. I wish to add additional Antenna pads, so how can I check that I will have sufficient power for them ?
A. Each Antenna has a milliamp usage (mA) as indicated on its label and the clock uses another 70mA. Each Bricon transformer can give up to 1500mA of power. You should therefore calculate the power requirements of your complete system and add an extra additional power transformer where necessary.
- Q. I have obtained a second antenna pad. What must I do in order for it to operate as part of my system ?
A. You must use antenna programming to re-number that pads own internal ID number held within its memory. Each antenna pad must have a different number to that of any other pad in the system.
- Q. What must I consider in order to have an additional antenna pad in a loft away from my existing loft ?
A. It may be advised to give this separate antenna pad its own separate power supply, as when you send power through a long cable (20+ metres) then the voltage levels may fall below the levels required for that pad.
- Q. I already have 6 antenna pads and wish to add more pads in my Speedy X-treme system. What do I need ?
A. When 7 or more pads are required, a Bricon antenna buffer must be fitted. Power must also be considered.

RACE PREPARATION & BASKETING

- Q. I need to be at two club headquarters at the same time. Can I use two Speedy X-treme to achieve this ?
A. Yes, two clocks can be used on the same antenna pad system using a Bricon split cable. Each clock should hold the same pigeon data and each clock must be returned to the club where it was used for basketing.
- Q. How can I race with my Speedy X-treme, when basketing is to take place on an alternative brand of master ?
A. You will need your Bricon Unives cable and also have the racepoint pre-entered into the Speedy X-treme..
- Q. Why is my Speedy X-treme clock showing a time variation against the master time on my basketing list ?
A. An old race remains active on the clock for which the internal time is being maintained. Delete all of the races from the clock and it will then be able to time synchronise itself with the master time signal once again.
- Q. How can I check that my club has deleted all of the previous races from my Speedy X-treme clock ?
A. Insert the power cable into the base of the clock, and go to the Basketed races icon (the 3rd icon ~ flag 1-2). Press the OK button and the details of any active races still sitting on the clock will be displayed on screen.

AT THE LOFT DURING A RACE

- Q. What must I look for on the display of my Speedy X-treme clock, after I have connected it for a race ?
A. On connection the clock will search for antennas and should state 'Clocking with x Ant - Waiting for pigeon', where x is the number of pad IDs found. It is important that this matches the number of pads in your system.
- Q. My clock has been connected in readiness for the return of race birds. How can I test my system ?
A. Hold two un-linked chip rings over the pads, alternately lifting one ring away from the pad then the other.
- Q. Waiting for race birds to return, I have noticed that there are already birds showing as recorded on the clock.
A. The clock will time any bird that has access to the pad, and thus birds not raced will record as trainers.
- Q. How can I view the details of the birds that have been recorded on my Speedy X-treme ?
A. The last bird recorded will show on the display, and press the orange navigation buttons to scroll through the earlier birds recorded. Pressing the OK button gives you two display options, large character view giving the birds year and last four numbers, its position and clocking time, whilst the more detailed screen view gives additional information including the birds full ring number, the racepoint, date and time.
- Q. Birds are timed on the Speed X-treme, but how can I find out how many are racers and how many trainers ?
A. When the clockings are displayed in detailed view, the bottom line will show the numbers of birds recorded, with T indicating the number of trainers timed and R the number of race birds clocked..

For your own question answered - please contact Mark Palmer on 0121 357 7172 or bricon.ets@live.com



Declaration of Conformity

Directive 1999/5/EC (R&TTE)

BRICON nv
Europark Oost 15C,
9100 Sint-Niklaas
Belgium

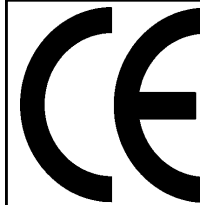

Loft antenna 1V-XXxxx
Loft antenna 2V-XXxxx
Loft antenna 4V-XXxxx
Loft antenna 6V-XXxxx

We declare on our own responsibility, that the products mentioned below to which this declaration relates, conform with the essential requirements and with other relevant provisions of the R&TTE directive (1999/5/EC).

Article: Loft Antenna
BRICON 1V(163mm), 2V(282mm), 4V(482mm), 6V(683mm).

Type: Reader for transponders (125kHz).

In accordance with Â§3 of R&TTE- the directive.

Health and Safety Â§3 (1) a:
Applied standard:
EN 60950:1992+A1+A2:1993+A3:1997+A11:1997

EMC §3(1)b:
Applied standard:
EN 301 489-3/07.200

Radio frequency spectrum Â§3 (2):
Applied standard:
EN 300 330-2 V1.1/7.2000

The technical file is available at the offices of the manufacturer.
BRICON nv, Europark Oost 15C, Sint-Niklaas, Belgium.

Place and date of issue: Sint-Niklaas, Belgium. 13-12-2005.

Responsible for the manufacturer: Ivan Baetens
CEO - Bricon nv

12. Technical specifications.

<i>Maximum number of pigeons : 300</i>
<i>Maximum number of races : 16</i>
<i>Number of fanciers : 1 or 3</i>
<i>Maximum number of antennas : 6</i>
<i>Maximum number of fields : 6 x 6 fields</i>
<i>With buffers added - max number of antennas : 96</i>
<i>Maximum cable length : 150 metres</i>